



LEOPARD FAMILY

BL-40RPM Leopard RPM Meter 4 Digit 0.56" LEDs in a 1/16 DIN CASE



An economically smart programmable meter relay with isolated 4 to 20 mA retransmission or control loop output capability for measurement and control applications in a 96 X 24 mm case.

General Features

- This meter has been designed specifically for RPM measurements. Just enter the pulses per revolution and the BL-40RPM meter will calculate and display the RPM reading.
- Three ranges with resolutions of 0.1 RPM, 1 RPM and 10 RPM (99.99 X 1000 RPM max.).
- Optional isolated 16 bit analog output. User or factory scalable to 4 to 20 mA, 0 to 20 mA or 0 to 10 V across any desired digital span from one count to the full scale range of 9999.
- Auto-sensing AC/DC power supply. For voltages between **85-265 V AC / 95-370 V DC (PS1)** or 15-48 V AC / 10-72 V DC (PS2).
- 24 V DC excitation is available to power external sensors.
- Standard red or optional green or super bright red 4-digit LED with display range 0 to 9999.
- Three annunciator LEDs provide front panel alarm status indication for up to three setpoints.
- One 10 Amp Form C and one 5 Amp Form A relay, or up to three 5 Amp Form A relays are available.
- When analog output is installed, one 10 Amp Form C or two 5 Amp Form A relays can be supported.
- Automatic intelligent averaging smooths noisy signals, while providing a fast display response to real level changes.

Software Features

- Three-button programming from the front panel (UP, DOWN and PROGRAM buttons).
- Three front panel selectable ranges.
- Front panel selectable four-level brightness control of digital display, and setpoint LEDs.
- Three programmable setpoints.
- Relay activation can be selected to occur above (HI) or below (LO) each setpoint.
- Hysteresis setting for all three setpoints. Delay on make and delay on break for SP1 and SP2.
- Peak and Valley. View and Reset.

Input Module Compatibility

There is 1 Plug-in Modular Input Signal Conditioner, IF05, for this specialized RPM only member of the Leopard Family.



LEOPARD

Specifications

- Input Specs:**Depends on input signal conditioner
- A/D Converter:**.....14 bit single slope
- Accuracy:**.....2 count
- Temp. Coeff.:**.....100 ppm/°C (Typical)
- Warm up time:**.....2 minutes
- Conversion Rate:**.....5 conversions per second (Typical)
- Display:**.....**4 digit 0.56" Red LED display (std)**,
0.56" Red, Green or Super Bright Red (optn). Range 9999 counts.
- Polarity:**.....Assumed positive.
- Decimal Selection:**....Front panel button selectable, X•X•X•X•
- Positive Overage:**..Top segments of digital display flash
- Relay Output:** Three 5 Amp Form A relays or one 10 Amp Form C, and one 5 Amp Form A relay.
- Analog Output:**.....Isolated 16 bit user scalable mA or V
OIC (mA out).....4-20 mA @ 0 to 500Ω max loop resistance
OIV (volts out)..... 0-10 V DC @ 500 Ω or higher resistance
- Power Supply:**.....AC/DC Auto sensing wide range supply
PS1 (std)**85-265 VAC / 95-370 VDC @ 2.5W max 3.2W**
PS215-48 VAC / 10-72 VDC @ 2.5W max 3.2W
- Operating Temp.:**.....0 to 60 °C
- Storage Temp:**.....-20 °C to 70 °C.
- Relative Humidity:**95% (non condensing)
- Case Dimensions:**.....1/16 DIN Bezel 96x24mm
Depth behind bezel 122.2mm (4.83")
Plus 12.7mm (0.5") for Right-angled connectors
- Weight:**.....7 oz, 9 oz when packed

Index

Case Dimensions..... 10	Functional Diagram..... 7	Other Leopard Family Meters 11	Software Logic Tree 3
Component Layout 9	General Features..... 1	Pin Descriptions 8	Specifications 1
Connector Pinouts 7	Glossary of Programming Symbols 2	Pulses Per Revolution, Range & Brightness Selection 4	Two Point Analog Output Range
Connectors 8	Input Module Compatibility 1	Setpoint Setting and Relay	Setting and Calibration 4
Controls and Indicators 2	I-Series Input Signal Conditioning	Configuration Mode 6	
Digital Span Selection for Analog Range Output 5	Modules..... 10	Software Features..... 1	
	Ordering Information..... 12		

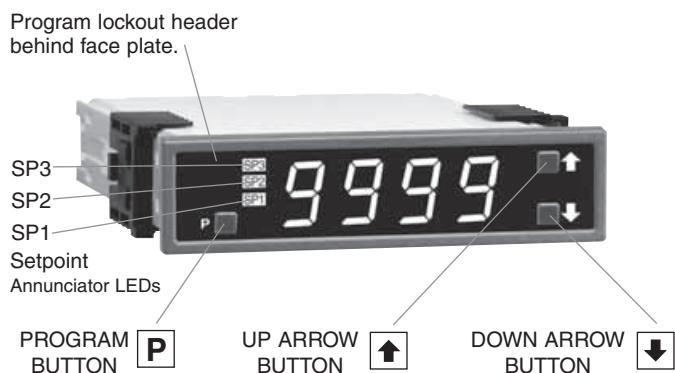

Front Panel Buttons

Program Button

The **P** button is used to move from one program step to the next. When pressed at the same time as the button, it initiates the **calibration mode**. When pressed at the same time as the button, it initiates the **setpoint setting mode**.

Up Button

When in the operational display, pressing the button alone, allows you to view and reset the Peak and Valley (Highest and Lowest Readings.)

When in the **calibration mode** or the **setpoint setting mode** the button is used to increase the value of the displayed parameter.

Down Button

When in the operational display, pressing the button alone, allows you to view, but not change, the setting of setpoint 1, 2 and 3.

When in the **calibration mode** or the **setpoint setting mode** the button is used to decrease the value of the displayed parameter.

Glossary of Programming Symbols

To explain software programming procedures, logic diagrams are used to visually assist in following the programming steps. The following symbols are used throughout the logic diagrams to represent the buttons and indicators on the meter:

Symbol

Explanation



This symbol represents the OPERATIONAL DISPLAY.



This is the PROGRAM button.



This is the UP ARROW button.



This is the DOWN ARROW button.



When a button is shown, press and release it to go onto the next step in the direction indicated by the arrow. When two or more buttons are shown, each with an arrow, this indicates that there is a number of programming choices.



When two buttons are shown side by side and enclosed by a dotted line, they must be pressed at the same time then released to go onto the next programming step.



If the display is shown with XXXX, it means the value displayed will be the previously set value. When a number is shown, it indicates the initial factory default setting or a specific "example number".

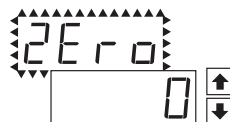

When two displays are shown together with bursts, this indicates that the display is toggling (flashing) between the name of the function and the value.

[Span]
[10000]

Text or numbers shown between square brackets in a procedure indicate the programming code name of the function or the value displayed on the meter display.

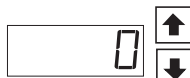

When the and buttons are shown together, the display value can be increased by pressing and releasing the button or decreased by pressing and releasing the button.

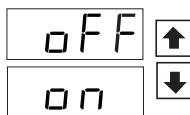

When the and buttons are shown with two displays, either display can be selected by pressing and releasing the or buttons.

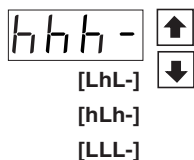

When there are more than two display selections they are shown in brackets below the first display and are also selectable by pressing and releasing the or buttons.

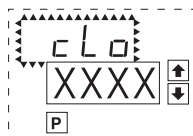

A dotted box indicates these functions are omitted or bypassed when the related hardware is not present.

Software Logic Tree

The BL-40RPM is an intelligent meter with a hierarchical software structure designed for easy programming and operation, as shown below in the software logic tree.

After the meter has been powered up, the four digits light up for three seconds and then settle to the operational display indicating the input signal.

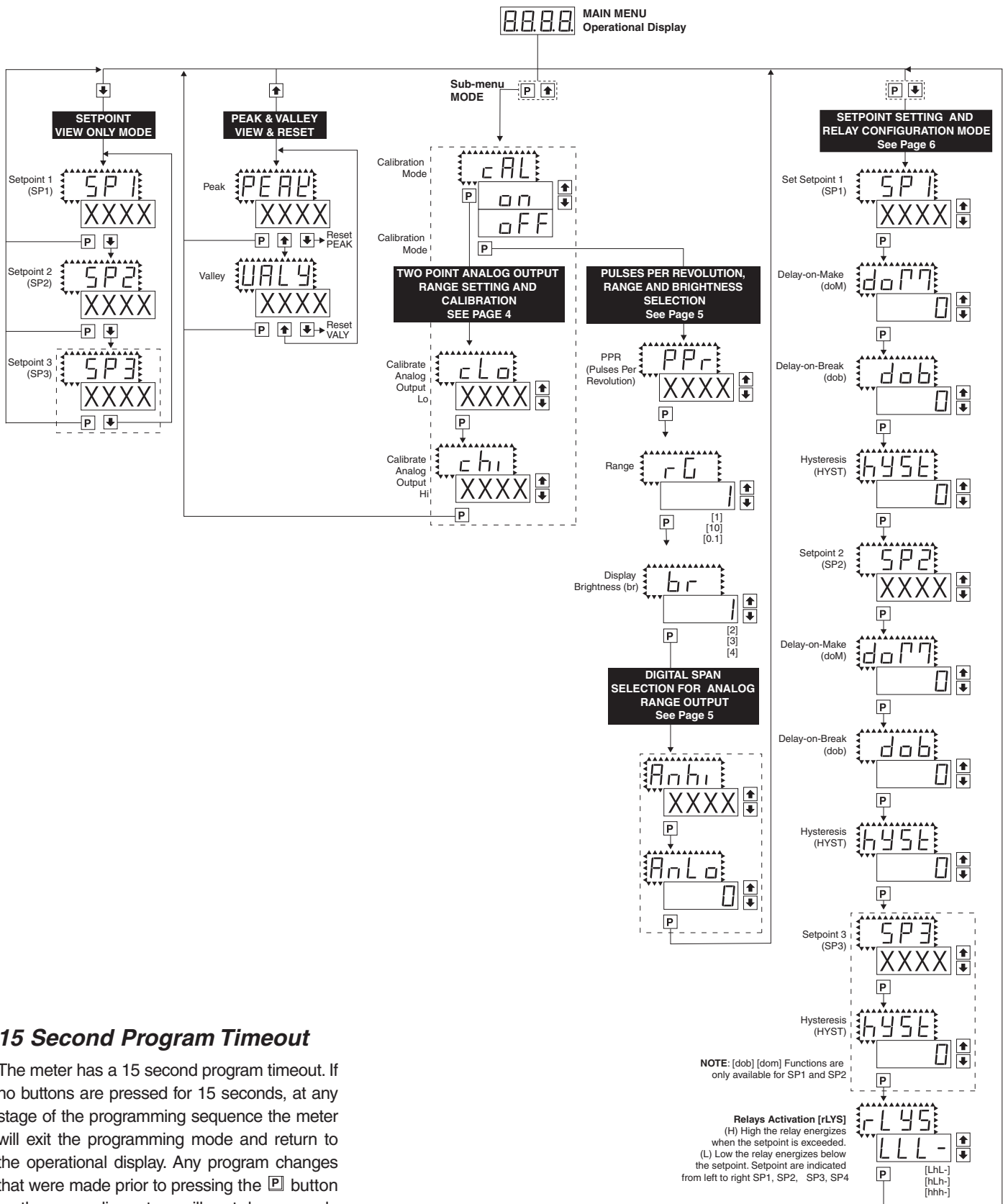

15 Second Program Timeout

The meter has a 15 second program timeout. If no buttons are pressed for 15 seconds, at any stage of the programming sequence the meter will exit the programming mode and return to the operational display. Any program changes that were made prior to pressing the **[P]** button in the preceding step will not be saved.

Two Point Analog Output Range Setting and Calibration

STEP A Enter the Calibration Mode

- 1) Press the **[P]** and **[↑]** buttons at the same time. Display toggles between [cAL] and [oFF] if the Analog Output option is installed.

Note: If at this point the display skips directly to toggle between [PPr] and the previous Pulses per revolution setting (STEP E) then the software is detecting that the optional analog output hardware is NOT installed.

STEP B Enter the [oUT] Analog Output Calibration Mode

- 1) Press the **[↑]** or **[↓]** button. Display changes from [oFF] to [on].
- 2) Press the **[P]** button. Display toggles between [cLo] and an internal scale factor.

STEP C Calibrate the [cLo] Low Analog Output

- 1) Select the voltage or current output header position on the output module. (See Component Layout on page 9).
- 2) Connect a multimeter to pins 16 and 17 on the output module. (See Rear Panel Pinouts on page 8). Using the **[↑]** and **[↓]** buttons, adjust the analog output to the desired low value as shown on the multimeter display. cLo may be adjusted to any value from -0.3 mA to 17 mA (mA output selected) or from -0.6 V to 8 V (volt output selected)
- 3) Press the **[P]** button. Display toggles between [chi] and an internal scale factor.

STEP D Calibrate the [chi] High Analog Output

- 1) Using the **[↑]** and **[↓]** buttons, adjust the analog output to the desired high value as shown on the multimeter display. chi may be adjusted to any value from 17 mA to 21 mA (mA output selected) or from 8 V to 10.3 V (volt output selected)
- 2) Press the **[P]** button. The display exits the calibration mode and returns to the operational display.

Note: Having established the Low and High range of the analog output, the digital span can now be selected which will set the two display points between which the analog output will occur. (See STEP I and STEP J on Page 5).

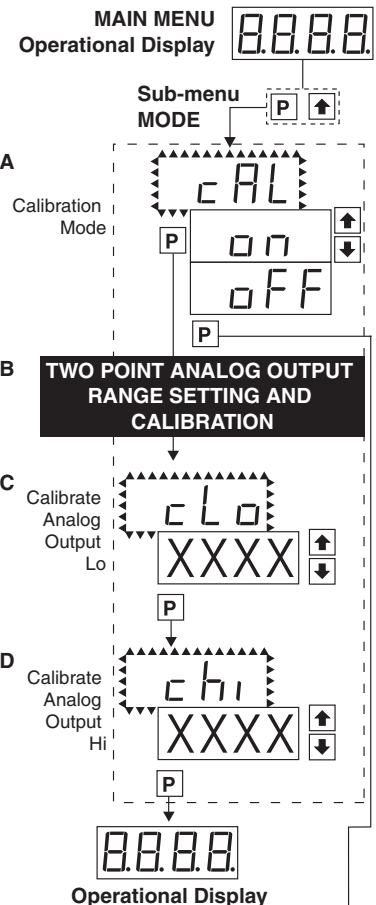

Pulses Per Revolution, Range and Brightness Selection

STEP E Enter the Range Selection Mode Through the Sub Menu [cAL] [oFF]

- 1) Press the **[P]** and **[↑]** buttons at the same time. Display toggles between [cAL] and [oFF].
- 2) Press the **[P]** button. Display toggles between [PPr] and the previous pulses per revolution setting.

STEP F Enter the Pulses per revolution (PPR)

- 1) Using the **[↑]** and **[↓]** buttons, enter the number of pulses per revolution. Any number between 1 and 9999 may be entered.
- 2) Press the **[P]** button. Display toggles between [rG] and the previous range setting.

STEP G Select the Range

- 1) Using the **[↑]** and **[↓]** buttons, select the appropriate range. There are three ranges with resolutions of 0.1 (max. 999.9 RPM), 1 (max. 9999 RPM) and 10 RPM (max. 99.99 X 1000 RPM).
- 2) Press the **[P]** button. Display toggles between [br] and the previous brightness setting.

STEP H Set the Display Brightness

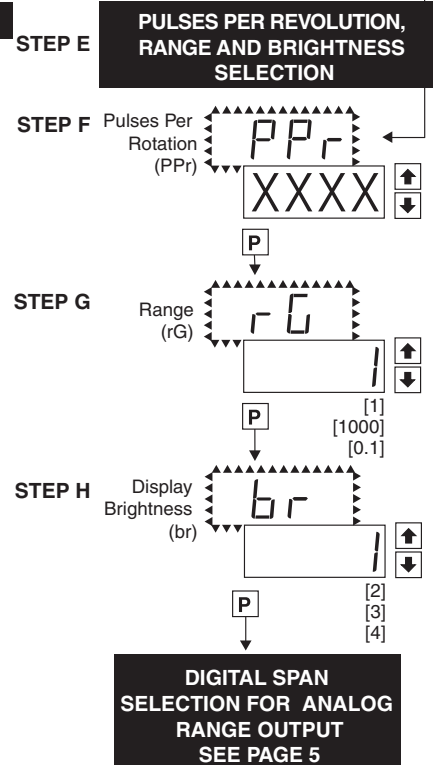

- 1) Using the **[↑]** and **[↓]** buttons, adjust the display to the desired brightness setting (4 is the brightest setting).
- 2) Press the **[P]** button. Display brightness changes to new setting and display toggles between [Anhi] and the previous [Anhi] setting, if the Analog Output Option is installed.

Note: If the Analog Output option is not installed then the displays returns to the operational display.





Digital Span Selection for Analog Range Output

STEP I Set the Display Corresponding to the Analog High Output

- 1) Using the  and  buttons, adjust the display to the desired value at which the selected analog high output will occur.
- 2) Press the  button. Display toggles between [AnLo] and previous [AnLo] setting.

STEP J Set the Display Corresponding to the Analog Low Output

- 1) Using the  and  buttons, adjust the display to the value at which the selected analog low output range will occur.
- 2) Press the  button. The display exits the calibration mode and returns to the operational display.

Note: Any two points from 0 to 9999 can be selected for which the specified analog output occurs. The display values for analog high and analog low can be reversed for reversed 20-4 mA output. The difference between the two display points can be as small as two counts however small spans cause the 16 bit D to A to increment in staircase steps.

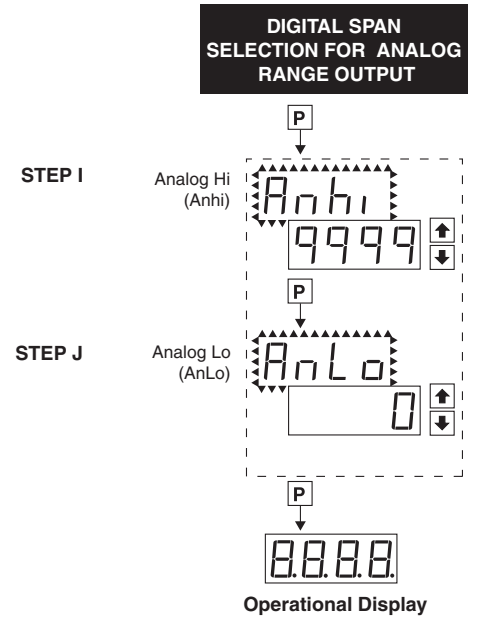

Setpoint Setting and Relay Configuration Mode

The following programming steps are required to enter the setpoint values and configure the relay functions in a meter with four relays using four setpoints. Generally if less than four relays are installed the software auto detects missing relays and deletes reference to them from the menu. In some cases setpoints without relays are operational for display only purposes.

STEP A Enter the Setpoint Mode

- 1) Press the **P** and **↓** buttons at the same time.
Display toggles between [SP1] and the previous [SP1] setting.

STEP B Set Setpoint 1 (SP1)

- 1) Using the **↑** and **↓** buttons, adjust the display to the desired SP1 value.
- 2) Press the **P** button. Display toggles between [doM] and the previous [doM] setting.

STEP C Set the SP1 Delay-on-Make (doM) Delay Time Setting

- 1) Using the **↑** and **↓** buttons, adjust the display to the desired [doM] value (0 to 9999 seconds). The reading must continuously remain in an alarm condition until this delay time has elapsed before the relay will make contact (energize).
- 2) Press the **P** button. Display toggles between [dob] and the previous [dob] setting.

STEP D Set the SP1 Delay-on-Break (dob) Delay Time Setting

- 1) Using the **↑** and **↓** buttons, adjust the display to the desired [dob] value (0 to 9999 seconds). The reading must continuously remain in a non-alarm condition until this delay time has elapsed before the relay will break contact (de-energize).
- 2) Press the **P** button. Display toggles between [HYSt] and the previous [HYSt] setting.

STEP E Set the Hysteresis Setting for Setpoint 1

- 1) Using the **↑** and **↓** buttons, adjust the display to the desired hysteresis [HYSt] value.
 - 2) Press the **P** button. Display toggles between [SP2] and the previous [SP2] setting.
- NOTE:** Half of the Hysteresis value selected is applied above and below the setpoint.

NOTE: Steps F, G, H and J have functionally the same procedure as steps B, C, D, and E shown above.

STEP F Set Setpoint 2 (SP2)

STEP G Set the SP2 Delay-on-Make (doM) Delay Time Setting

STEP H Set the SP2 Delay-on-Break (dob) Delay Time Setting

STEP I Set the Hysteresis Setting for Setpoint 2

- 1) Using the **↑** and **↓** buttons, adjust the display to the desired hysteresis [HYSt] value.
- 2) Press the **P** button. Display toggles between [SP3] and the previous [SP3] setting.

STEP J Set Setpoint 3 (SP3) (No [doM] or [dob])

- 1) Using the **↑** and **↓** buttons, adjust the display to the desired SP3 value.
- 2) Press the **P** button. Display toggles between [HYSt] and the previous [HYSt] setting.

STEP K Set the Hysteresis Setting for Setpoint 3

- 1) Using the **↑** and **↓** buttons, adjust the display to the desired hysteresis [HYSt] value.
- 2) Press the **P** button. Display toggles between [rLYS] and the previous relay setting.

STEP N Set Relay Activation mode [rLYS]

(H) High the relay energizes when the setpoint is exceeded. (L) Low the relay energizes below the setpoint. The setpoint is indicated from left to right SP1, SP2, and SP3.

- 1) Using the **↑** and **↓** buttons, adjust the reading on the display to the desired relay settings: [LLL-], [LHL-], [LLH-], [HHH-].
If only 2 relays installed [LH] [HL] [HH] [LL].
- 2) Press the **P** button.
The meter exits the setpoint mode and returns to the operational display.

The Setpoint Relay programming mode is now complete.

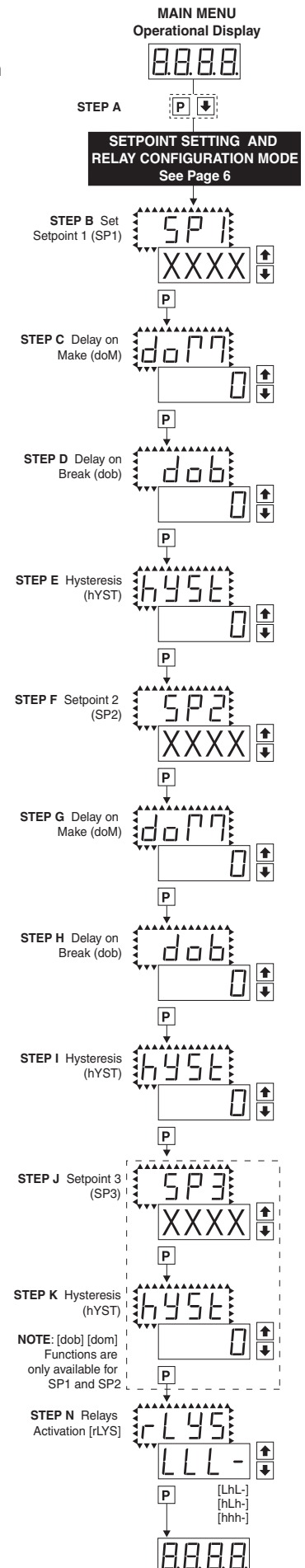

Functional Diagram

This specialized RPM member of the Leopard Family accepts only the input signal conditioning module shown below.

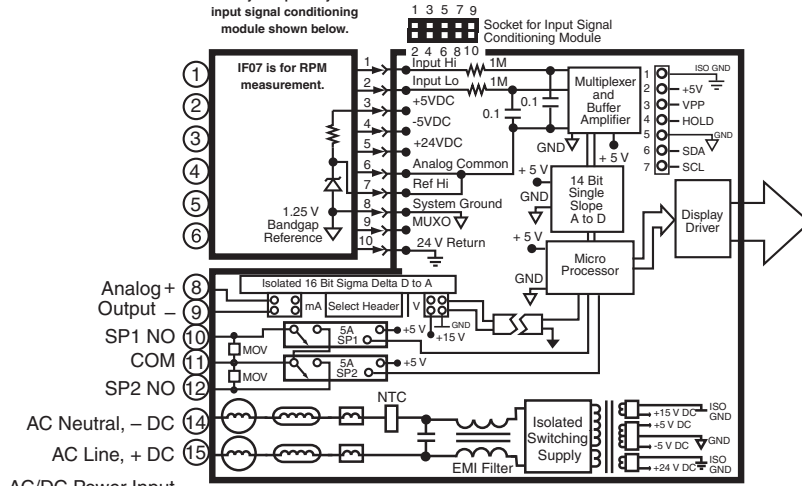

BL-40RPM Functional Diagram with analog output and two 5 Amp Form A relays

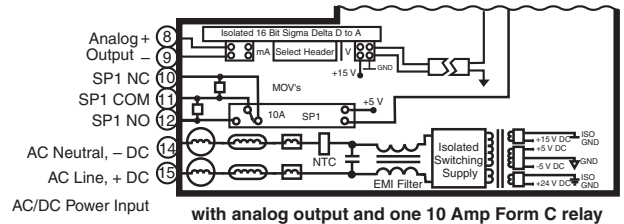

with analog output and one 10 Amp Form C relay

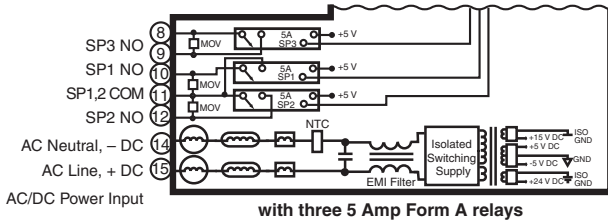

with three 5 Amp Form A relays

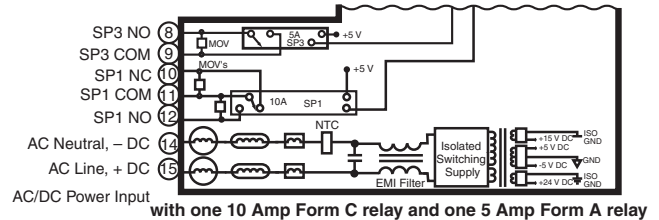

with one 10 Amp Form C relay and one 5 Amp Form A relay

Connector Pinouts

This meter comes standard with screw terminal plug connections.

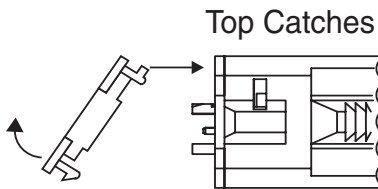

Release From Bottom

TO REMOVE REAR COVER

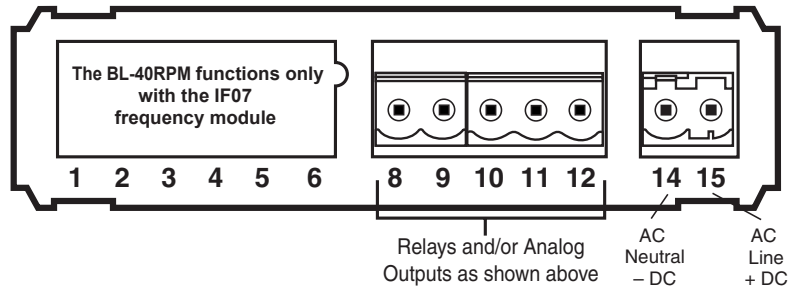

Auto-sensing AD/DC power supply

PS1 85 to 265 VAC
95 to 370 VDC

PS2 15 to 48 VAC
10 to 72 VDC

Connectors

This meter uses plug-in type screw terminal connectors for all input and output connections. The power supply connections (pins 14 and 15) have a unique plug and socket outline to prevent cross connection. The main board uses standard right-angled connectors.

Replacement 2-, 3-, and 4-pin plug connectors are available (see Accessories on page 12).

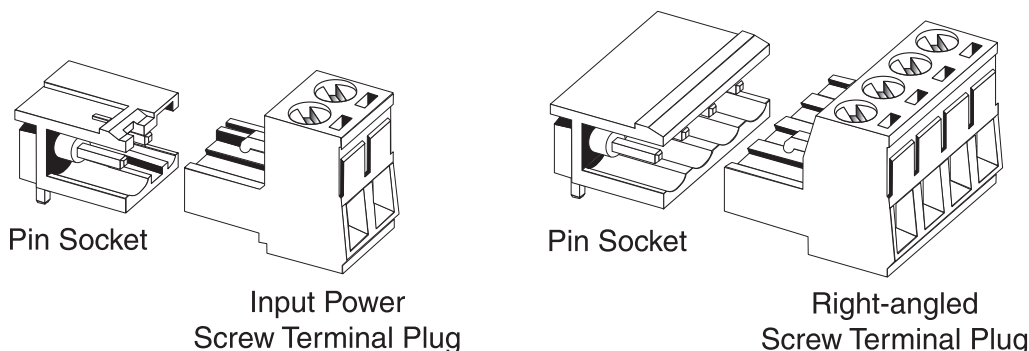

WARNING: AC and DC input signals and power supply voltages can be hazardous. Do Not connect live wires to screw terminal plugs, and do not insert, remove or handle screw terminal plugs with live wires connected.

Pin Descriptions

Input Signal – Pins 1 to 6

Pins 1 to 6 are reserved for the input signal conditioner. See the data sheet for the selected input signal conditioner.

Pins 8 to 12 – Relay and Analog Output Pins

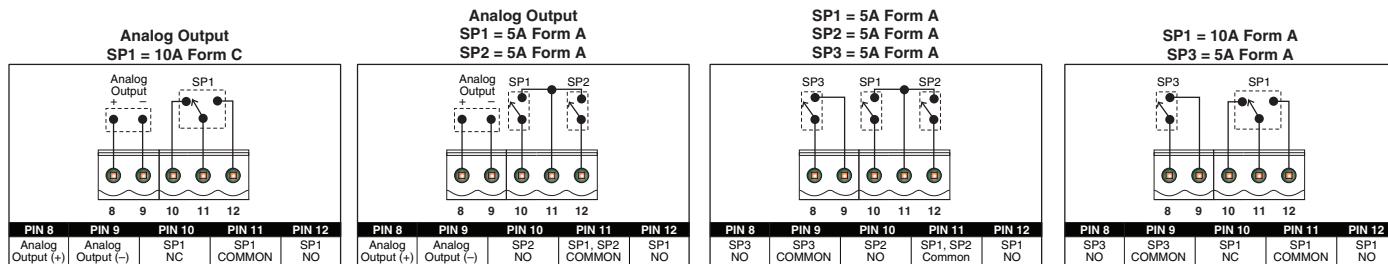

Pins 14 and 15 – AC/DC Power Input

Auto sensing AC/DC power supply. For voltages between 85-265 VAC or 95-370 VDC (PS1).

Pin 14 & Pin 15 - AC/DC Power Input: These pins are the power pins of the meter and they only accept a special polarized screw terminal plug that can not be inserted into any other input socket. The standard meter has a auto sensing AC/DC power supply that operates from 85-265 VAC/95-370 VDC (PS1 Std). An optional isolated low voltage power supply that operates from 15-48 VAC/10-72 VDC (PS2) is also available.

Internal Header Pin out

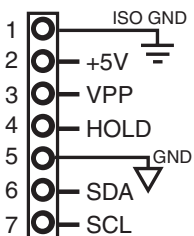

Internal header pins 1, 2, 3, 6, and 7 are for factory settings only. Not for external use!

4 HOLD. By connecting the HOLD pin to the GND pin, the displayed reading is frozen, however, A/D conversions continue. When the HOLD pin is disconnected from the GND pin, the correct reading is displayed.

5 GND. This pin is connected to the internal power supply ground.

4 to 20 mA
(0 to 20 mA)
Selection Position

Analog Output
Selection Header

0 to 10 V DC
Selection
Position

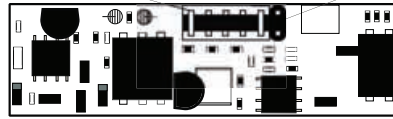

Optional Analog Output Module

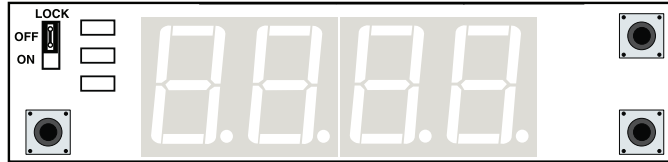

Display Board Front View

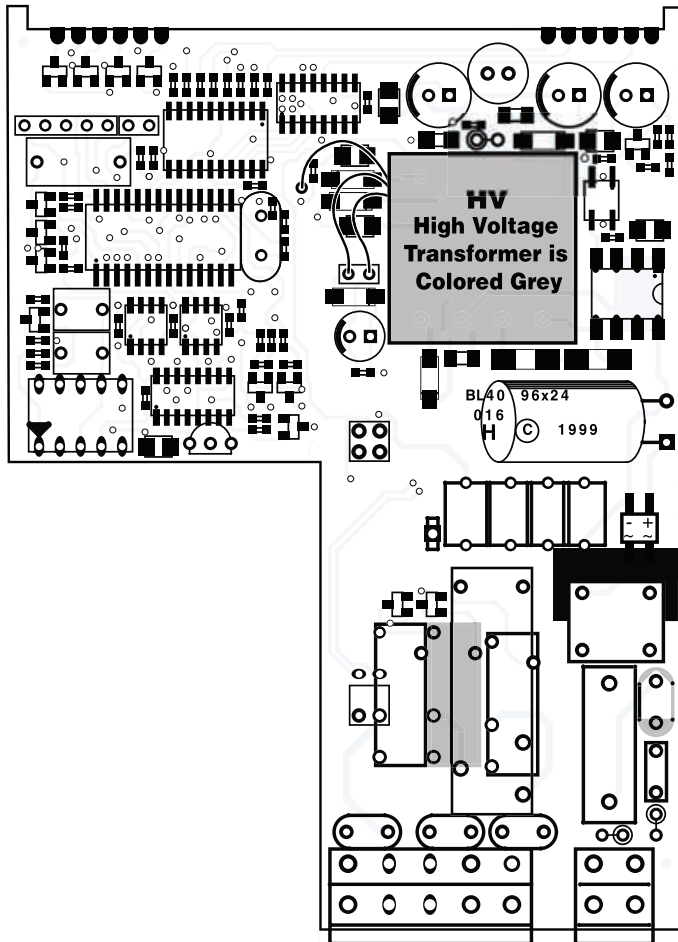



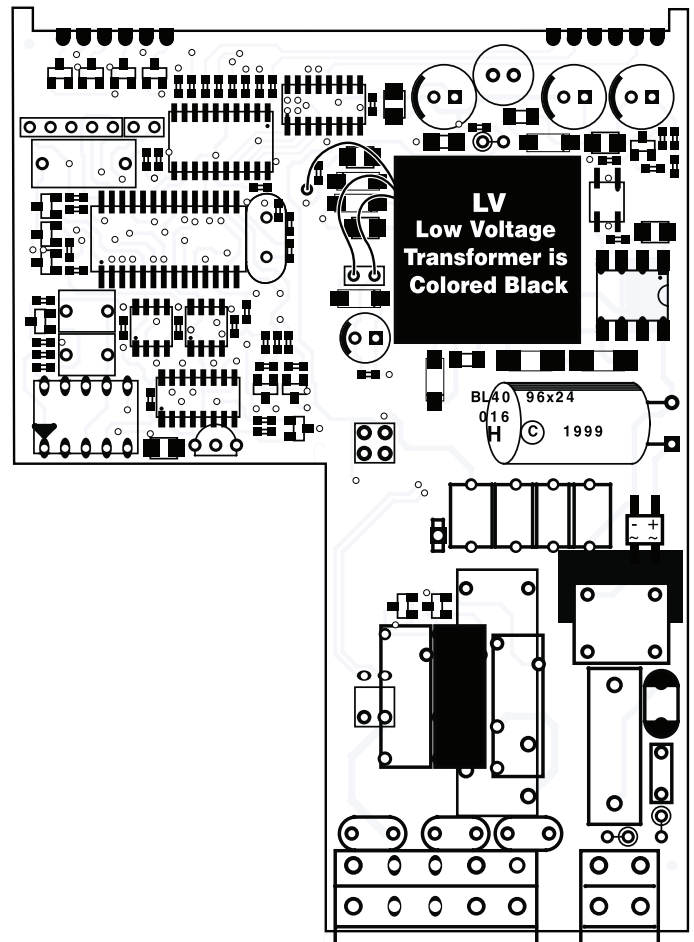





**PS1 High Voltage
Main Board**



**PS2 Low Voltage
Main Board**

I-Series Input Signal Conditioning Modules

Symbols Indicate Module Compatibility Within Meter Families

 TIGER Family	 TIGER Family	 TIGER Family
 LEOPARD Family	 LEOPARD Family	 LEOPARD Family
 LYNX Family	 LYNX Family	 LYNX Family
ALL MODELS	SOME MODELS	MODEL SPECIFIC

Unless otherwise specified Texmate will ship all modules pre-calibrated with factory preselected ranges and/or scalings as shown in **BOLD** type. Other pre-calibrated standard ranges or custom ranges may be ordered. Factory installed custom scaling and other custom options are also available (see Ordering Information, Special Options on last page).

IF05: Universal Frequency / RPM

Using NPN Open Collector Proximity Switch

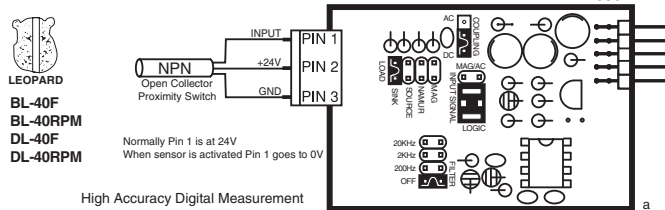

WARNING: AC and DC input signals and power supply voltages can be hazardous. Do Not insert, remove or handle modules with live wires connected to any terminal plugs.

Case Dimensions

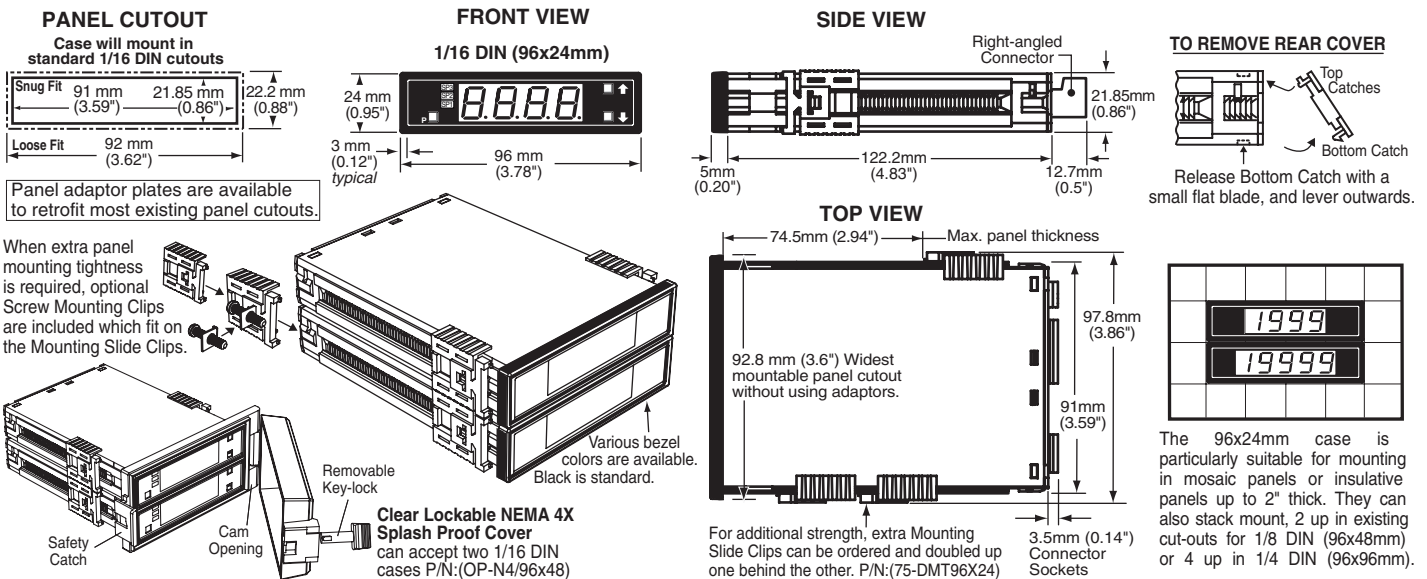



Leopard Family Meters and Bargraphs

INTERNATIONAL	
DIN	
CASES	
1/32	1/8

Smart, Programmable Bargraph Relays with Isolated 16 Bit 4-20 mA or 0-10 V Outputs

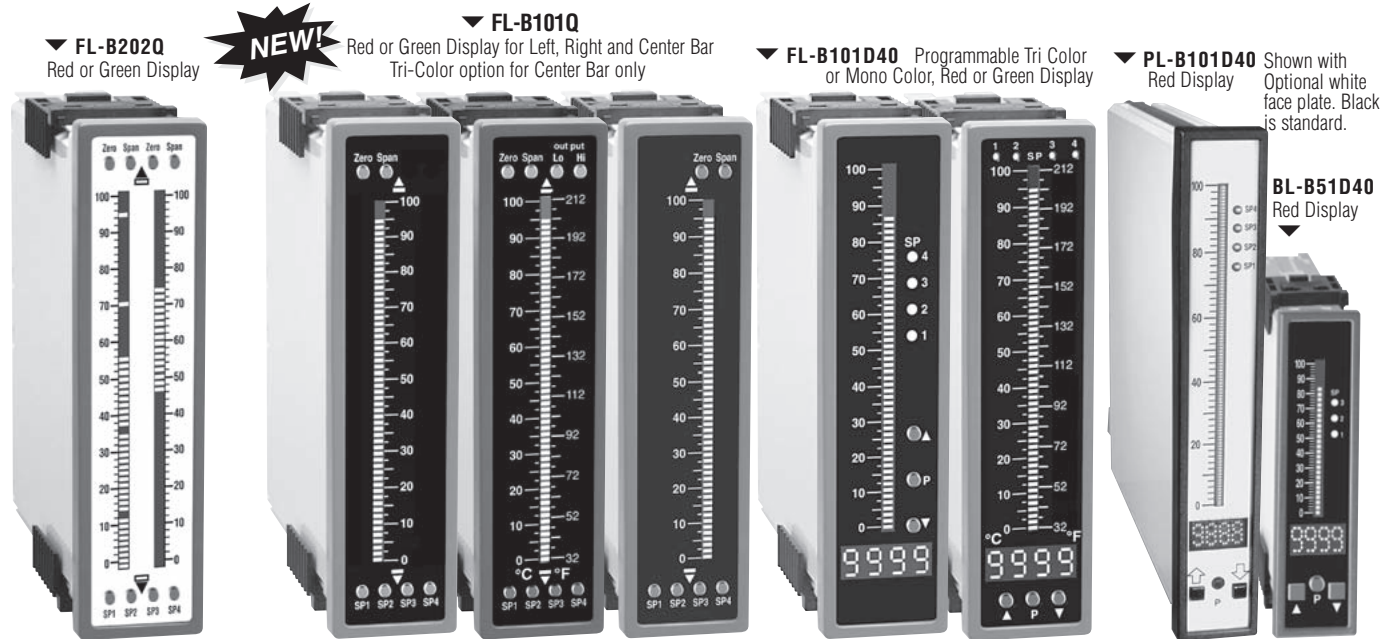

9/64 DIN 36x144 mm (1.42"x5.69")

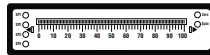
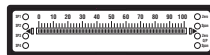

3/32 DIN
24x144 mm
(0.95"x5.69")

1/16 DIN
24x96 mm
(0.95"x3.78")

LEOPARD FAMILY FEATURES

- Smart 4 digit meters, tricolor and mono-color bargraphs
- Front-panel digital scaling, offset, and setpoints
- Bargraph can be independently scaled to a sensitivity of 100 counts full scale within any portion of the digital scale
- Over 38 different I-Series Input Signal Conditioners. For more info, please refer to the "I-Series Input Signal Conditioning Modules" catalog.
- 24 V DC excitation is available to power external 4-20 mA transmitters and 5 or 10 V DC excitation is available for resistance bridge type sensors
- Dual 10 & 5-amp relays, 4 relays total plus 16-bit analog output
- 1/16 DIN meters have one 10 Amp relay or two 5 Amp relays plus 16-bit analog output or an extra 5 Amp relay
- Auto-sensing AC/DC, wide range power supplies, 85-265 V AC / 95-370 V DC or 18-36 V AC / 9-60 V DC
- Quick, easy mounting into any panel thickness
- Direct flush mount into mosaic panels
- Optional NEMA 4X membrane touch screen face plates
- Optional NEMA 4X, IP65 clear polycarbonate lens covers
- Optional metal surround case for DL and FL meters.
- Standard plug-in screw terminal connectors are provided



▲ FL-B101D40PS with horizontal face plate option
Programmable Tri Color or Mono Color, Red or Green Display



▲ FL-B202Q horizontal face plate option
Red or Green Display



▲ DL-40 w/0.8" display option



▲ DL-40 Water Proof Membrane Touch-pad Option



▲ DL-40

Ordering Information

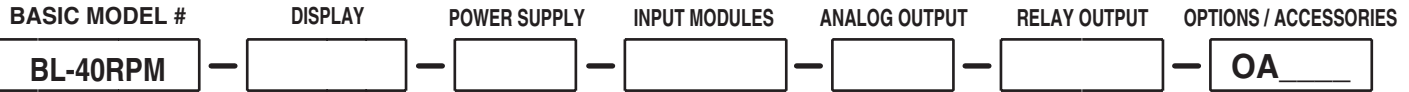

Add to the basic model number the order code suffix for each standard option required. The last suffix is to indicate how many different special options and or accessories that you may require to be included with this product.

Ordering Example: BL-40RPM-DR-PS1-IF07-0IC-R1-OA2, the 2 OA's are, CR-CHANGE and a 75-DMT96X24

► BASIC MODEL NUMBER

BL-40RPM . 96x24mm, Leopard, 4 Digit RPM Meter

Standard Options for this Model Number

Order Code Suffix	Description
-------------------	-------------

► DISPLAY

DR . . Red LED, 0.56 inch high

DB . . . Super-bright Red LED, 0.56 inch high

DG . . . Green LED, 0.56 inch high

► POWER SUPPLY

PS1 . 85 - 265VAC / 95 - 370VDC

PS2 . . . 18 - 48VAC / 10 - 72VDC

► INPUT MODULES (Partial List. See www.texmate.com)

Unless otherwise specified Texmate will ship all modules precalibrated with factory preselected ranges and/or scalings as shown in **BOLD** type.

IF05 . . . Universal Frequency/RPM

► ANALOG OUTPUT*

OIC . . . Isolated analog 4-20mA (with a Max. Two-5A Form A Relays)

OIV . . . Isolated analog 0-10VDC (with a Max. Two-5A Form A Relays)

*Note: When either of the Analog Output options is installed, only the R1, R2 and R11 Relay Output options can be co-installed (see below).

► RELAY OUTPUT

R1 . . . Single 5A Form A Relay

R2 . . . Dual 5A Form A Relays

R3 . . . Three 5A Form A Relays; SP1 & SP2 common**

R11 . . Single 10A Form C Relay

R16 . . Single 10A Form C & Single 5A Form A Relays**

**R3 & R16 cannot be co-installed with Analog Output options.

Special Options and Accessories (OA's)

Part Number	Description
-------------	-------------

► SPECIAL OPTIONS (Specify Inputs or Outputs & Req. Reading)

CR-CHANGE Calibrated Range Change to another Standard Range
 CS-L/40 Custom Scaling within any Std. or Custom Selectable Range
 CSR-L/40 Custom Selectable Range Installation or Modification
 CSS-L/40 Custom Special Scaling beyond the Standard Range
 COA-L/SINGLE Custom Output - Special Scaling of Analog Output
 COR-L/RELAY Custom Output - Relays Installed in Non-Standard Locations
 CCP-L/SETUP NRC to Set-up Custom Configuration - Functions, Codes
 CCP-L/INSTL Factory Installation - Custom Configuration

► ACCESSORIES (Specify Serial # for Custom Artwork Installation)

75-DMT96X24 Side Slide Brackets (2 pc) - extra set, extra strength
 75-DBBZ96X24 Extra Black Bezel for 96x24mm Case
 ART-FS-S/D/C NRC for artwork & set-up Faceplate/Desc/Co.Logo
 ART-FS-S/D NRC for artwork & set-up Faceplate/Desc
 ART-FS-001 Install Custom Faceplate per meter - 1 color
 93-PLUG2P-DP Extra Screw Terminal Conn., 2 Pin Power Plug
 93-PLUG2P-DR Extra Screw Terminal Conn., 2 Pin Plug
 93-PLUG3P-DR Extra Screw Terminal Conn., 3 Pin Plug
 93-PLUG4P-DR Extra Screw Terminal Conn., 4 Pin Plug
 DN.CAS96X24L Extra Complete 96x24mm Case with bezel
 OP-MTLCLIP Screw Mounting Clips (2 pc) to screw tighten slide brackets
 75-DTP96X24 Black Metal Trim Plate (96x24mm Case) 1 Meter
 75-DTP2X9624 Black Metal Trim Plate (96x24mm Case) 2 Meters
 75-DTP3X9624 Black Metal Trim Plate (96x24mm Case) 3 Meters

Many other options and accessories are available. See full price list for more details.

Prices subject to change without notice.

WARRANTY

Texmate warrants that its products are free from defects in material and workmanship under normal use and service for a period of one year from date of shipment. Texmate's obligations under this warranty are limited to replacement or repair, at its option, at its factory, of any of the products which shall, within the applicable period after shipment, be returned to Texmate's facility, transportation charges pre-paid, and which are, after examination, disclosed to the satisfaction of Texmate to be thus defective. The warranty shall not apply to any equipment which shall have been repaired or altered, except by Texmate, or which shall have been subjected to misuse, negligence, or accident. In no case shall Texmate's liability exceed the original purchase price. The aforementioned provisions do not extend the original warranty period of any product which has been either repaired or replaced by Texmate.

USER'S RESPONSIBILITY

We are pleased to offer suggestions on the use of our various products either by way of printed matter or through direct contact with our sales/application engineering staff. However, since we have no control over the use of our products once they are shipped, **NO WARRANTY WHETHER OF MERCHANTABILITY, FITNESS FOR PURPOSE, OR OTHERWISE** is made beyond the repair, replacement, or refund of purchase price at the sole discretion of Texmate. Users shall determine the suitability of the product for the intended application before using, and the users assume all risk and liability whatsoever in connection therewith, regardless of any of our suggestions or statements as to application or construction. In no event shall Texmate's liability, in law or otherwise, be in excess of the purchase price of the product.

Texmate cannot assume responsibility for any circuitry described. No circuit patent or software licenses are implied. Texmate reserves the right to change circuitry, operating software, specifications, and prices without notice at any time.



995 Park Center Drive • Vista, CA 92081-8397

Tel: 1-760-598-9899 • USA 1-800-839-6283 • That's 1-800-TEXMATE

Fax: 1-760-598-9828 • Email: sales@texmate.com • Web: www.texmate.com

Texmate has facilities in Japan, New Zealand, Taiwan, and Thailand. We also have authorized distributors throughout the USA and in 28 other countries.

For product details visit www.texmate.com

Local Distributor Address