



Available in stackable cases (see rear page)



## CM-35XT

Loop-Powered Panel Meter  
3 1/2 Digit 0.48" LCD  
in a Slim Bezel Case

A Multirange, Easily-Scaled, 4-20 mA Process Meter.

### General Features

The CM-35XT is specially designed to simplify installation, calibration and scaling. It is one of the CM-Series family of meters. Deriving their operating power from the current loop, these meters require no external power supply. The CM-35XT is a functional replacement for the now obsolete CM-35X meter. Its counterpart, the CM-35XTL, has the same pinout as the CM-35XT but requires only a 1.0V loop drop to operate, making it particularly suitable for current loops that would otherwise exceed their power supply capacity with too many devices connected.

The meters feature Display Hold, Display Test and Auto-Polarity Indication. The polarity indication may be disabled or reversed by repositioning jumper clips on internal header pins. Another feature of the CM-series meters is the 4 1/2 digit LCD display which provides for a non-active trailing dummy zero or a °C/°F descriptor. Descriptor indication may be disabled or re-programmed by repositioning jumper clips on internal header pins.

### Typical Application Connections

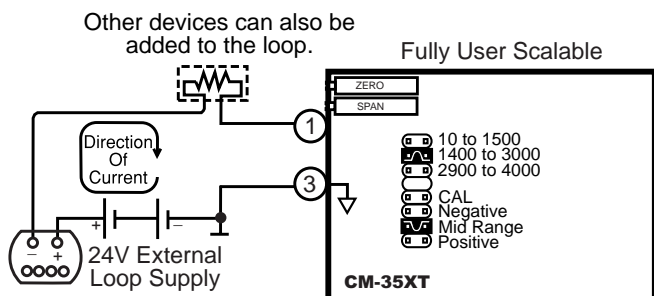

### Compatibility

The CM-Series is shipped in a standard Slim Bezel case. The Slim Bezel case is compatible with the TM, SM, PM, & SP Series of meters. The CM-Series can be ordered in End Mount cases for twin mounting or combinations of multiple center mount cases and two end mount cases for stack mounting.

#### SLIM



#### BEZEL

### Specifications

- Input Configuration:** .....Series connection to 4-20mA DC current loop
- Full Scale Ranges:** .....Standard meter is adjustable to any scaling between -1999 to +1999 or -19990 to +19990 with the dummy zero enabled
- Input Impedance:** .....5.1 Volts drop, plus 70.8Ω (equivalent to 6.5V Maximum @ 20mA)
- Maximum Overcurrent:** .....200mA continuous
- A/D Converter:** .....12 bit dual slope
- Accuracy:** .....± (0.05% of reading + 2 digits)
- Maximum Resolution:** .....± 1999 counts
- Gain Temp. Coefficient:** .....0.2 counts/°C typical
- Zero Temp. Coefficient:** .....0.15 counts/°C typical
- Conversion Rate:** .....3 readings per second
- Display:** .....0.48" Liquid Crystal Display (LCD)
- Descriptors:** .....Header programmable trailing dummy zero, °C or °F
- Polarity:** .....Automatically displays either "+" or "-"; header programmable polarity disable and reversal
- Decimal Selection:** .....User programmable to three positions
- Over-range Indication:** .....When input exceeds full scale on any range being used, most significant "1" digit and polarity symbol are displayed with all other digits blank.
- Power Supply:** .....NO SEPARATE POWER SUPPLY IS REQUIRED; as the unit derives its power from the 4-20mA current loop signal
- Operating Temperature:** .....-20°C to +50°C
- Storage Temperature:** .....-20°C to +70°C
- Relative Humidity:** .....95% (non condensing)
- Case Dimensions:** .....Bezel (2.755"W x 1.170"H) 69.68mmW x 29.72mmH  
Depth behind bezel (3.315") 84.2mm  
Plus (0.685") 17.4mm for connector
- Weight:** .....143 gms (5 oz) when packed

## CM-Series, The Choice for Loop-Powered Meters

CM-35XT .....3.5 digit LCD, Loop Powered, 4-20mA (1.0.0.0.0)

CM-35XTL .....3.5 digit LCD, 1 Volt Drop, Loop Powered, 4-20mA (1.0.0.0.0)

# Functional Diagram

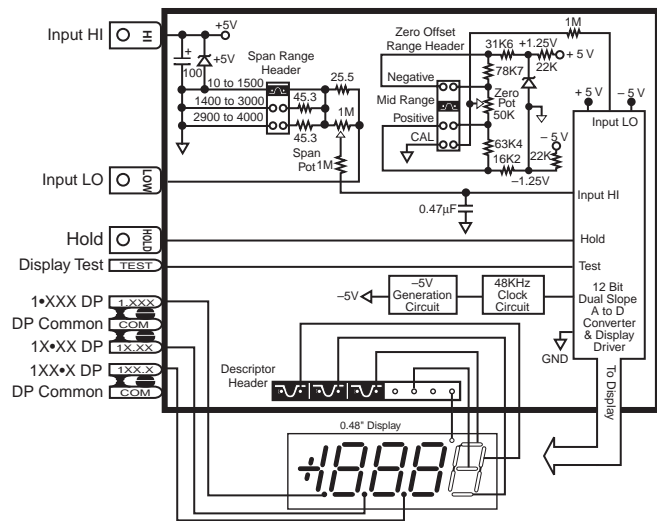

# Connector Pinouts

For most applications where it is not necessary to activate Display Test or remotely change the selected decimal point, the three screw terminal blocks supplied with the meter can be used to connect Current Loop High Input, Current Loop Low Return and Display Hold Input. For other applications, the Texmate CM-35XT interconnects by means of a standard PC board edge connector having two rows of 10 pins each, spaced on 0.156" centers. Connectors are available from Texmate, or from almost any connector manufacturer.

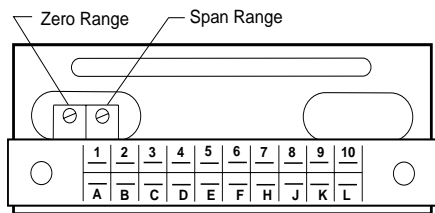

## METER REAR WITH PCB EDGE CONNECTOR MOUNTED

(For mounting of screw terminal blocks see rear page)

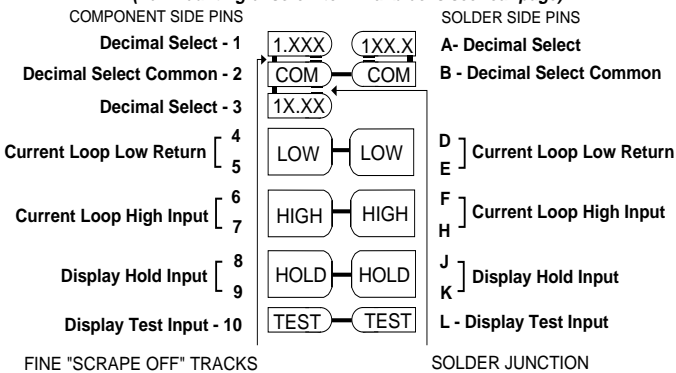

**Pins A, 1 and 3 - Decimal Select:** Decimal points may be blanked as required by carefully scraping off the fine tracks linking these pins to Decimal Select Common using a pair of pliers or a small screwdriver blade. Re-connect either by linking the appropriate pins on the connector or by solder-bridging the junctions located on the PC board edge fingers.

**CAUTION:** Do not connect the decimal select pins to any pins other than Decimal Select Common Pins B & 2. Although the decimals may become activated if an improper connection is made to other pins, this will eventually cause permanent damage to the LCD display.

**Pins B and 2 - Decimal Select Common:** Common return pins for decimal point selection (see CAUTION above).

**Pins (D, E) & (4, 5) - Current Loop Low Return:** The 4-20mA current loop is returned from Pins (D, E) & (4, 5). At 4mA the meter displays the minimum reading. At 20mA the meter displays the maximum reading.

**Pins (F, H) & (6, 7) - Current Loop High Input:** The 4-20mA current loop is applied to Pins (F,H) & (6,7) and returned from Pins (D, E) & (4, 5). If reverse polarity is applied no damage will occur; however the meter will not operate (this condition should not be maintained for extended periods).

**Pins (J, K) & (8, 9) - Display Hold Input (CMOS compatible):** If Pins (J, K) & (8, 9) are left open, the meter will operate in a free-running mode. When Pins (J, K) & (8, 9) are connected to Current Loop High Input Pins (D, E) & (4, 5) the meter will latch up; A/D conversions will continue but the display will not be updated until Pins (J, K) & (8, 9) are released.

**Pins L and 10 - Display Test Input:** All numeric display segments will operate when Pins L and 10 are connected to Current Loop High Input Pins (D, E) & (4, 5).

Note: Because of the additional current drawn by the circuit in display test mode, 20mA loop current is required for reliable in-circuit display test activation.

**CAUTION:** The Display Test function is only intended for momentary operation. Continuous application of Display Test will, in time, damage the LCD display.

# Component Layout

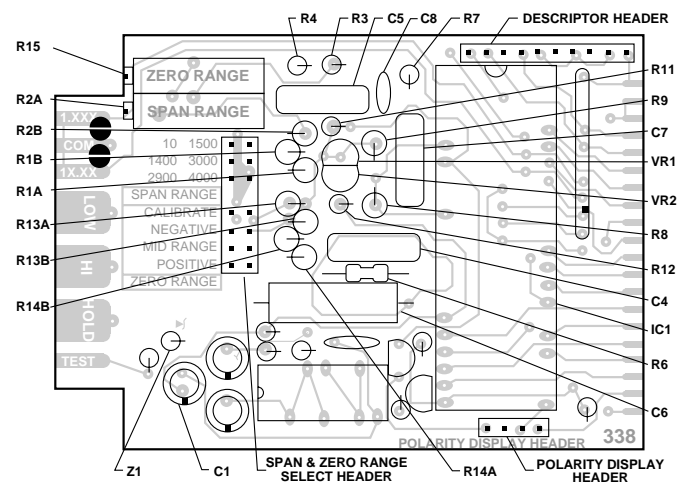

# Signal Conditioning Component

**ZERO Potentiometer (Pot)**

The ZERO pot when installed is to the left of the SPAN pots (as viewed from the back of the meter). Typically it enables the displayed reading to be offset ±1000 counts.

**SPAN Potentiometer (Pot)**

The 15 turn SPAN pot is always on the right side (as viewed from the front of the meter). Typical adjustment is 20% of the input signal range.

**Polarity Display Header**

This header allows the Polarity indication to be displayed normally, displayed reversed or to be disabled completely.

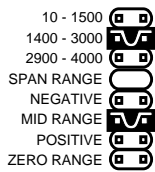

## SPAN ADJUST Header

Any input Signal Span can then be scaled down to provide a required Digital Display span from  $\pm 19999$  (40000 counts) to 0001 (one count).

## DESCRIPTOR SELECTION

The CM-35XT is designed with a 3 1/2 digit A/D converter and a 4 1/2 digit display. The right-most digit can be enabled to display different symbols such as 0, °C or °F. This trailing non-active zero can be used to display engineering units such as 15000 rpm instead of 15.00k rpm as required with 3 1/2 digit displays.

The meter is shipped with the jumpers in the '0' position. To disable all segments, remove all the jumper clips from the descriptor header.

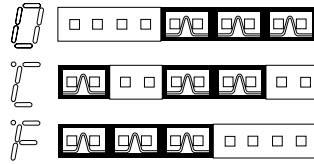

FRONT OF METER ⇒

## Calibration Procedure

The CM-35XT functions by measuring the voltage drop caused by the 4-20mA signal loop current flowing through a sensing resistor located inside the meter. The voltage sensed is scaled by an adjustable potential divider network and converted to a digital reading in counts, shown by the LCD display. Because the loop current does not go down below 4mA, it is usually necessary to "Zero Offset" the meter reading. This enables zero or some other appropriate value to be displayed at 4mA, even though the voltage across the sensing resistor is not zero. The Zero Offset may be disabled by putting the ZERO RANGE jumper clip into the CALIBRATE position.

### DEFINITION OF SPAN AND ZERO OFFSET

The **SPAN** is defined here as the **total change in counts on the display when the signal loop current varies from 4mA to 20mA**. Note that decimal points and/or non-active trailing zero are descriptors, and so are excluded from the calculation. Example: If the required readings are +190.0 at 20mA and -30.0 at 4mA, then the SPAN is (+1900) minus (-300), or 2200 counts. The **ZERO OFFSET** is simply defined here as the **displayed counts at 4mA**. In the example above, the ZERO OFFSET is -300 counts.

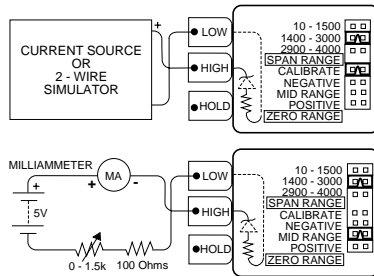

### CALIBRATION

One header & potentiometer calibrate the span range (the change in meter reading between 4mA and 20mA). The second header & potentiometer calibrate the zero offset (the meter reading at 4mA). To avoid interaction between the SPAN RANGE and ZERO RANGE potentiometers, the calibration is performed in the following sequence:

#### 1. Calibrate the SPAN

Place a jumper clip in the CALIBRATE position on the ZERO RANGE Select Header. This disables the ZERO RANGE potentiometer. Depending upon the calculated SPAN, place a jumper clip in the appropriate position on the SPAN RANGE header. In the above example, this would be the position marked 1400-3000.

Apply an input of 4mA to the meter. This input can be derived either from a Current Calibrator (fig. 1), a 5V DC supply /resistor combination (fig. 2) or from within a current loop, by varying the loop transmitter transducer appropriately. Adjust the SPAN RANGE potentiometer (R2) to make the meter display one quarter of the calculated SPAN. In the previous example the meter would be adjusted to show  $2200 \div 4$ , i.e. 550 counts. Once calibrated, the display changes by 550 counts for a loop

current change of 4mA. Therefore when the input changes by 16mA (i.e. from 4 to 20mA), the display will change by  $550 \times 4 = 2200$  counts.

#### 2. Calibrate the ZERO OFFSET

Remove the ZERO RANGE jumper clip from the CALIBRATE position and replace it in the NEGATIVE, MID RANGE or POSITIVE position, depending on whether the required meter reading at 4mA is a large negative, close to zero, or a large positive reading. In the previous example, place the jumper clip in the MID RANGE position. Adjust the ZERO RANGE potentiometer (R15) to make the meter display indicate the correct reading (-300 in the example).

#### 3. Check the Scaling

Apply loop currents of 4mA and 20mA. Verify that the meter indicates correctly at both currents. Slight adjustments to the SPAN RANGE and ZERO RANGE potentiometers may be required.

#### 4. Program Decimal Points and/or Trailing Descriptor

Refer to the "Decimal Point Selection" section on page 4 for decimal point programming. Refer to the "Descriptor Selection" section alongside for descriptor header jumper clip positions.

### CALIBRATION OF "REVERSE" SCALINGS

"Reverse" scalings that require a more positive reading at 4mA than at 20mA, such as 100.0 at 4mA and 0.0 at 20mA can be accomplished by calibrating the meter to indicate -1000 at 4mA & 000 at 20mA and then reversing the display polarity indication. Refer to the "Polarity Display Header" section on this page for polarity reversal.

## TB-Kit Screw Connectors

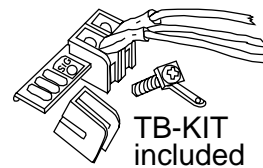

TB-KIT included

Texmate's individual screw terminal blocks offer a convenient alternative to edge connectors for many applications, allowing complete installation, configuration and calibration without the need for soldering.

Slide each terminal block over the PCB until the hole aligns. Insert the retaining screw to secure.

Each kit includes: 3 plastic blocks with metal contacts, 4 screws with spade connectors, 1 metal contact and 3 quick disconnects.

## Decimal Point Selection

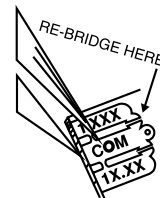

The meter is shipped from the factory with all the decimal points on. To turn off unwanted decimals, use a pair of long-nosed pliers to scrape of the fine tracks connecting decimals to decimal select common (alternatively, use a scalpel or small screwdriver). Reconnect by soldering where shown.

## Power Supply

The CN-35XT derives its power from the 4-20mA current loop signal.

## Push-On Screw Terminals

They provide the greatest convenience and ease of use

Texmate's exclusive optional Push-On Connectors combine an edge card connector and a 10 position screw terminal block. Push-On Connectors are ordered preconfigured for each specific power supply voltage and each optional power supply available for the CM-Series.



Part Number: CN-PUSH/CM

## CM Case Dimensions and Panel Cutouts

The Slim Bezel Case is supplied as standard. If specified at time of ordering, any combination of Twin Mounting and Multiple Array Cases may be substituted at no additional cost. Extra cases may be ordered separately.

### STANDARD SLIM BEZEL CASE

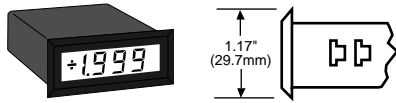

**SLIM BEZEL CASE**  
Standard Black ABS case with matte finish bezel for single unit mounting.  
Part No. **SL-CASERED** for LED's  
**SL-CASECLR** for LCD's

### OPTIONAL TWIN MOUNTING OR MULTIPLE ARRAY CASES

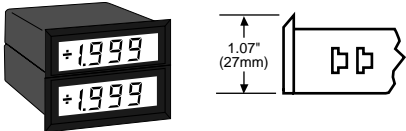

**END MOUNT CASE**  
Same styling as Slim Bezel case but with bottom edge of bezel removed. Two End Mount cases can be twin mounted in a single cutout.  
Part No. **EM-CASERED** for LED's  
**EM-CASECLR** for LCD's

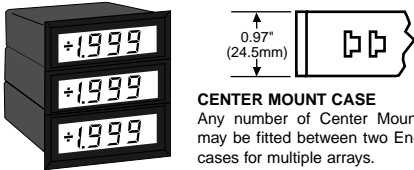

**CENTER MOUNT CASE**  
Any number of Center Mount cases may be fitted between two End Mount cases for multiple arrays.  
Part No. **CM-CASERED** for LED's  
**CM-CASECLR** for LCD's

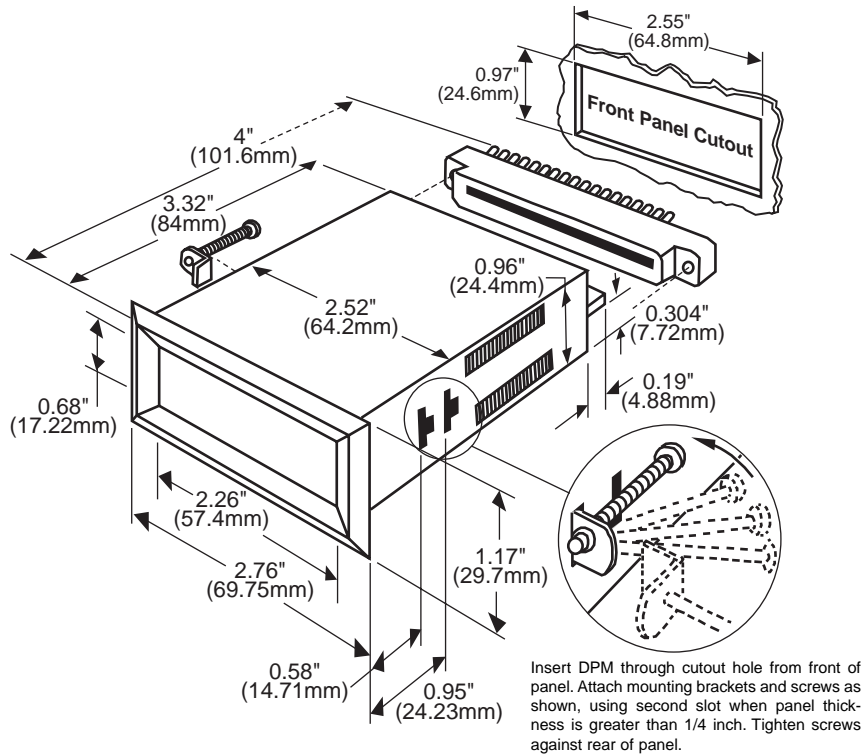

Insert DPM through cutout hole from front of panel. Attach mounting brackets and screws as shown, using second slot when panel thickness is greater than 1/4 inch. Tighten screws against rear of panel.

## Ordering Information

### Standard Options for this Model Number

Part Number	Description
<b>► BASIC MODEL NUMBER</b>	
CM-35XT	3.5 digit LCD, Loop Powered, 4-20mA
<b>► SPECIAL OPTIONS (Specify Req. Reading)</b>	
CB-FS35	Non-Std Scale Changes, 3.5 Digit Meters

### Special Options and Accessories

Part Number	Description
<b>► ACCESSORIES</b>	
CN-L10	PCB Edge Connector, Solder Type, Dual Row 10 Pins
CN-PUSH/CM	CM Series Push-on Screw Terminal Block Connector
SL.CASECLR	Slim Bezel Case, Clear Faceplate w/Mtg Hardware
CM.CASECLR	Center Mount Case, Clear Faceplate w/Mtg Hardware
EM.CASECLR	End Mount Case, Clear Faceplate w/Mtg Hardware
TB-KIT	Replacement Terminal Block Connector Kit (3)

Many other options and accessories are available. See full price list for more details. Prices subject to change without notice.

### WARRANTY

Texmate warrants that its products are free from defects in material and workmanship under normal use and service for a period of one year from date of shipment. Texmate's obligations under this warranty are limited to replacement or repair, at its option, at its factory, of any of the products which shall, within the applicable period after shipment, be returned to Texmate's facility, transportation charges pre-paid, and which are, after examination, disclosed to the satisfaction of Texmate to be thus defective. The warranty shall not apply to any equipment which shall have been repaired or altered, except by Texmate, or which shall have been subjected to misuse, negligence, or accident. In no case shall Texmate's liability exceed the original purchase price. The aforementioned provisions do not extend the original warranty period of any product which has been either repaired or replaced by Texmate.

### USER'S RESPONSIBILITY

We are pleased to offer suggestions on the use of our various products either by way of printed matter or through direct contact with our sales/application engineering staff. However, since we have no control over the use of our products once they are shipped, NO WARRANTY WHETHER OF MERCHANTABILITY, FITNESS FOR PURPOSE, OR OTHERWISE is made beyond the repair, replacement, or refund of purchase price at the sole discretion of Texmate. Users shall determine the suitability of the product for the intended application before using, and the users assume all risk and liability whatsoever in connection therewith, regardless of any of our suggestions or statements as to application or construction. In no event shall Texmate's liability, in law or otherwise, be in excess of the purchase price of the product.

Texmate cannot assume responsibility for any circuitry described. No circuit patent or software licenses are implied. Texmate reserves the right to change circuitry, operating software, specifications, and prices without notice at any time.

# TEXMATE INC

995 Park Center Drive • Vista, CA 92081-8397

Tel: 1-760-598-9899 • USA 1-800-839-6283 • That's 1-800-TEXMATE

Fax: 1-760-598-9828 • Email: sales@texmate.com • Web: www.texmate.com

Texmate has facilities in Japan, New Zealand, Taiwan, and Thailand. We also have authorized distributors throughout the USA and in 28 other countries.

For product details visit [www.texmate.com](http://www.texmate.com)

Local Distributor Address